

HomeSafe-G

VT-G992E

User's Manual



GSM & PSTN Home Alarm System

Table of Contents

| | |
|---|----|
| 1. Product Overview | 3 |
| 2. Main Functions & Features | 3 |
| 3. For Your Safety | 4 |
| 4. VT-G992E Characteristics | 4 |
| 5. Getting Started..... | 5 |
| 5.1 Standard Package List..... | 5 |
| 5.2 View | 5 |
| 5.3 Functional Parts | 6 |
| 5.4 Connecting and Installation | 8 |
| 6. Operation Instructions: <i>the factory password is: 0000</i> | 12 |
| 6.1 Keyboard setting:..... | 12 |
| 6.1.1 Password: | 12 |
| 6.1.2 Siren alarm sound enable/disable: | 12 |
| 6.1.3 Set up alarm calling telephone numbers: | 12 |
| 6.1.4 Delete alarm calling telephone numbers: | 12 |
| 6.1.5 Siren alarm sound time out: | 12 |
| 6.1.6 Alarming delay:..... | 12 |
| 6.1.7 ARMING delay:..... | 12 |
| 6.1.8 Remote telephone ringing times:..... | 12 |
| 6.1.9 Siren sound feedback when using the remote control:..... | 13 |
| 6.1.10 Voice reminder function on/off and buzzer sound on/off: | 13 |
| 6.1.11 Alarm message recording: | 13 |
| 6.1.12 Register and Delete remote controller/sensors: | 13 |
| 6.1.13 Setting wired zones L1/L2: | 13 |
| 6.1.14 Zone mode settings: | 14 |
| 6.1.15 Alarm event history: | 14 |
| 6.1.16 Telephone line tampering detection:..... | 14 |
| 6.1.17 Remote controller enable/disable:..... | 14 |
| 6.1.18 Remote control OUT power output: | 14 |
| 6.1.19 Setting up the system time and timing ARM/DISARM: | 14 |
| 6.2 GSM messaging prompting:..... | 15 |
| 6.2.1 Editing SMS prompting messages; (9 groups | 15 |
| 6.2.2 Set the types of 6 groups alarming telephone number and power failure | 15 |
| 6.2.3 Set the brightness adjustment of digital display | 15 |
| 6.2.4 SMS commands: where 0000 is the password | 15 |
| 7. Remote Controller (Key fob) Description | 16 |
| 7.1. Set up Arm..... | 16 |
| 7.2 Set up Disarm..... | 16 |
| 7.3. Emergency Alarm..... | 16 |
| 7.4. Intelligent Arm..... | 16 |
| 8. Alarm Panel LED Screen Indicator Status Description: | 16 |
| 9. Remote Control the system:..... | 17 |
| 10. Handing Incoming Alarm Phone Calls | 17 |
| 11. Reset Factory Settings..... | 17 |
| 12. Copyright and Disclaimer..... | 17 |

1. Product Overview

VT-G992E is a GSM and PSTN intelligent home alarm system. This LED display alarm system is equipped with dual network GSM & PSTN technologies and suitable for both home and commercial use. It uses advanced GSM technology, GSM Wireless mobile and traditional PSTN landline networks with intelligent alarm system. It has highly integrated digital voice, SMS, self-learning wireless communication code, and text-messaging technologies. The alarm provides automatic voice or SMS messaging as notification for incidents. It is a choice of stability, reliability, security, and user-friendliness. Features are very practical, cost-effective, and easy to use. This LED display alarm can integrate with many alarm accessories including door sensors, smoke detectors, gas detectors, emergency buttons and other accessories to build a powerful security setup. It has been widely used in homes, factories, schools, shops, convenience stores, financial and banking workplaces, community centres and residential areas to provide protection to valuable assets.

2. Main Functions & Features

VT-G992E has the following main functions and features:

- 99 Wireless Zones and 2 wired zones with LED display
- DC12V output(connect to wired sensors)
- Support both GSM & PSTN telephone
- English voice operation instruction
- LED indicator Arm/Disarm/Stay arm/Alarm/Setting/Signal
- Password protection function
- 5 groups of call phone number and SMS number, 1 group of emergency phone number and SMS number
- Programmable alarm delay: 0-99 seconds
- Programmable alarm arming delay: 0-99 seconds
- Programmable Siren sounding: 0-30 minutes
- Zone name self-editing function
- Programmable ring times
- Timing arm and Timing disarm
- Stay intelligent arm
- Multi-Zones Triggered Mode (2 or more than 2 zones)
- Repeat triggered alarm function (sensor alarm after triggered twice)
- Doorbell
- Anti-decoding protection function
- Telephone line cutting detection
- External power on and off SMS notification
- Remote control via SMS and Phone
- Remote control output for door open or light,...
- Remote control to turn on and off Siren
- Remote Monitoring/Arm/Disarm/Play records
- Two way talking (External)

3. For Your Safety

Read these simple guidelines. Not following them may be dangerous or illegal.

Proper Connection

When connecting with other device, read carefully its manual so as to carry out correct installation. Do not connect it to other incompatible devices.

Qualified Accessories

Use only original parts and peripheral equipments to avoid damage to VT-G992E.

Water Resistance

VT-G992E is not water resistant. Keep it dry. Install it inside the house

Confidential Phone Number

For safety reason, do not tell other people the mobile phone number of your VT-G992E without taking precautions of security settings.

4. VT-G992E Characteristics

| Items | Specification |
|--------------------------|--|
| Power Supply | DC12V / 1A |
| Backup Battery | Ni-Hi AAA*6 DC7.4V |
| Frequency | GSM 900/1800/1900Mhz |
| Standby current | < 55 mA |
| Alarm current | < 450 mA |
| Wireless frequency | 433MHz |
| Support wireless sensors | EV1527/300K 2262/1.5-4.7M |
| Wireless distance | 100m open |
| Record voice message | 10s |
| LED screen | display time/Arm/Disarm/Stay arm/Alarm/Setting |
| Operating temperature | -10° to 50° C |
| Humidity | 5% to 95% Non-condensing |
| Dimension | 33*25*7.5cm |
| Weight | 1.2KG |

5. Getting Started

This section will describe how to set up your VT-G992E.

5.1 Standard Package List

VT-G992E is supplied in a box which includes:



5.2 View



Front View



Side View



Back View

5.3 Functional Parts



| LED screen display | |
|---------------------------|--|
| F4 | GSM is unavailable |
| F5 | Turn on GSM |
| F6 | Access GSM network |
| 88:88 | Minutes : Seconds |
| LED indicator | |
| POWER | Power LED light, power supply working normal |
| ALARM | Alarm LED light, alarm system alarm |
| TELEPHONE | Telephone LED light, telephone line work normal |
| MOBILE | Mobile LED flashes every 3 seconds, GSM network working normal; If the LED still light, access GSM network fail |
| Microphone | |
| Function keyboard | |
| ARMING | ARMING LED light, the alarm system into arm status |
| INTELLIGENT | INTELLIGENT LED light, the alarm system into intelligent status |
| DISARMING | DISARMING LED light, the alarm system into disarm status |
| ALARM | ALARM LED light, the alarm system into alarm status |
| Speaker | |
| | English voice operation instruction |
| Digital Keyboard | |
| | Setting alarm system function |

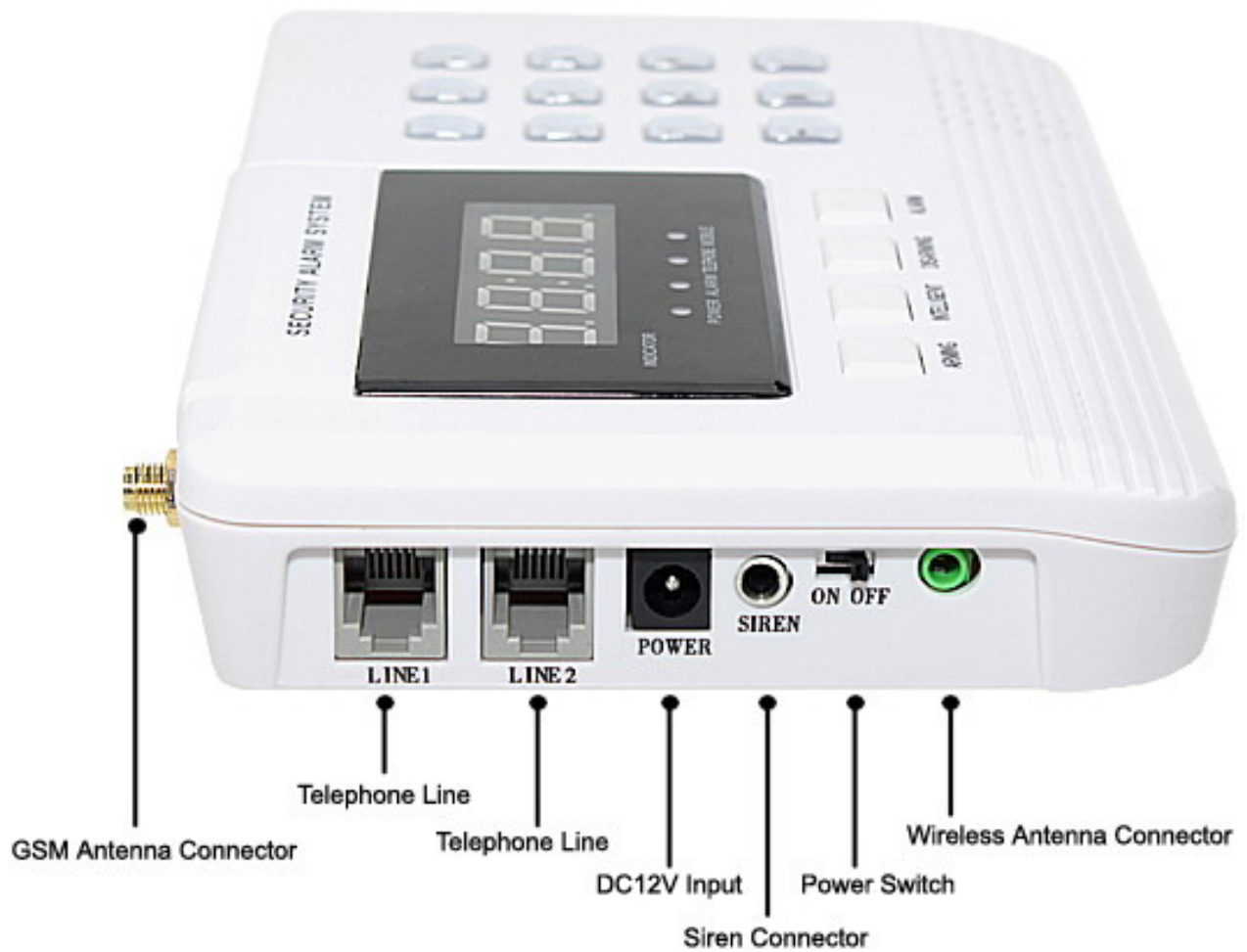

| | |
|-----------------------------------|---|
| GSM Antenna Connector | Connect GSM antenna |
| LINE1 | Connect LINE1 to telephone uses telephone wire of standard package list |
| LINE2 | Connect LINE2 to telephone out line |
| POWER | Connect DC12V adapter uses power adapter of standard package list |
| SIREN | Connect siren uses siren of standard package list |
| ON OFF | Power on battery or power off battery |
| Wireless Antenna Connector | Connect wireless antenna increase wireless distance |

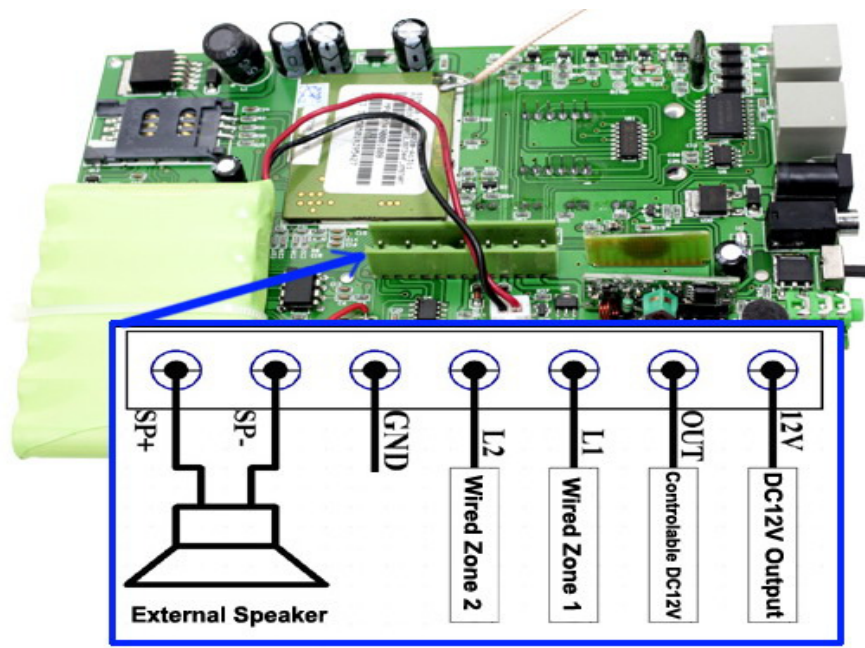

| | |
|-------------------------|--|
| External Speaker | |
| SP+ | Connect speaker anode |
| SP- | Connect speaker negative |
| GND | Connect wired zones COM port / Output DC12V negative |
| Wired zones | |
| L1 | Wired zone 1, connect wired sensors NC or NO port |
| L2 | Wired zone 2, connect wired sensors NC or NO port |
| OUT | It is a can be programmed to control the output of the DC12V |
| 12V | DC12V output, It can supply power for wired sensors |

5.4 Connecting and Installation

Read this manual before using your VT-G992E and check if all parts are included in the packaging box.

4.4.1 Ensure that your VT-G992E has a 2G working SIM installed.

Before inserting SIM card, cut off the power for VT-G992E.

Install SIM Card

- Open the SIM card cover at the back of VT-G992E.
- Insert the SIM card by sliding it into the card slot with the chip module facing to the connectors on PCB.
- Put back the SIM card cover.
- Check that the SIM has not run out of credit (test the SIM in a phone to make sure it can call succeed)
- Check that the SIM Lock code is turned off
- If you require the function of sending an SMS to the mobile phone number when it makes a alarming, please make sure the SIM card have balance and the message function.

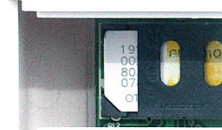

Check that the MOBILE LED is flashing 1 second on and 3 seconds off.

If the MOBILE LED still light or the LED screen shows F4, please turn off the power, check the SIM slot or GSM antenna and then turn on again



4.4.2 Antenna Connection

Connect the GSM antenna to VT-G992E

Connect the Wireless antenna to VT-G992E.

- GSM antenna is used to receive GSM signals. It should not be covered or shielded by any objects containing metal.



5.5 Sensor Installation:

Door sensor

The door/window magnetic sensor has two parts. The small part is the magnet to be mounted on the door and the others, the sensor is to be mounted on the frame of the door. The sensor will be activated and will send the wireless signal to the controller immediately when the two.

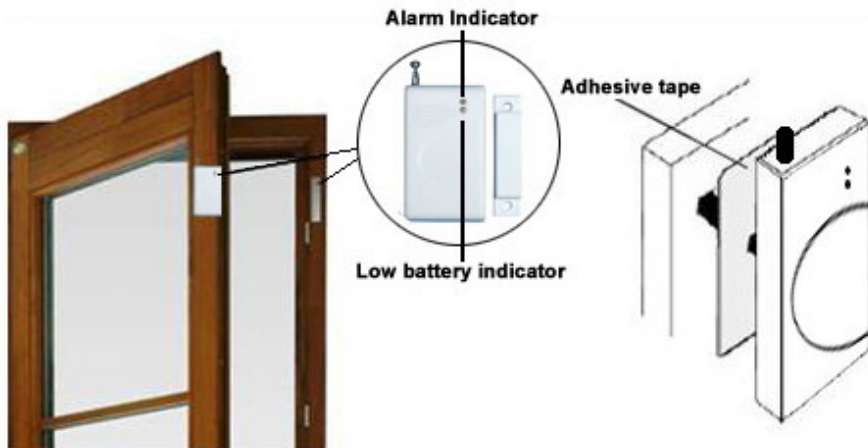

In some circumstances the wired & wireless Infrared Fence detector is more appropriate than magnetic sensors.



Wired or wireless glass break detector:



Wireless scroll steel door magnetic sensor:



Install PIR motion sensor:

A Passive Infra-red (PIR) Sensor is an electronic device that detects the motion or movement of some person or animal by sensing the heat emitted from the body.

Installation:

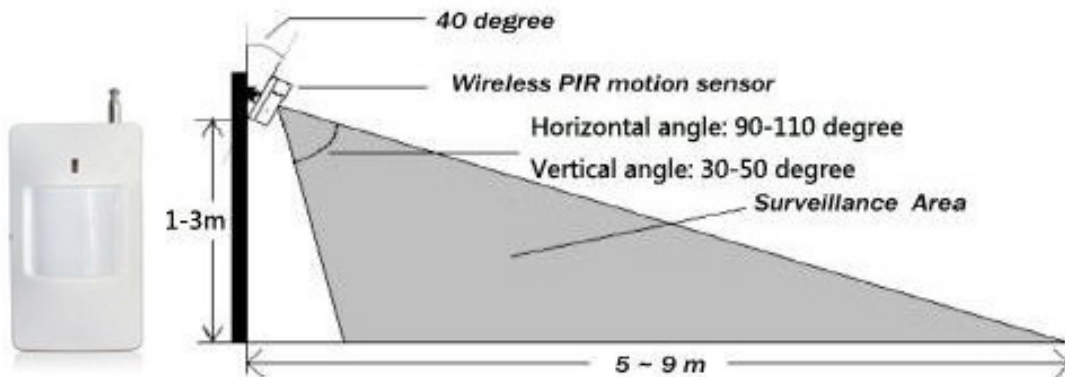

The installation of wireless ceiling PIR sensor

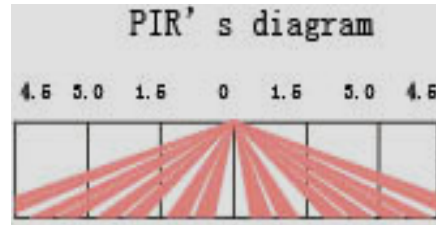
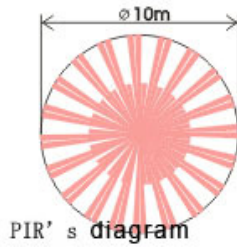
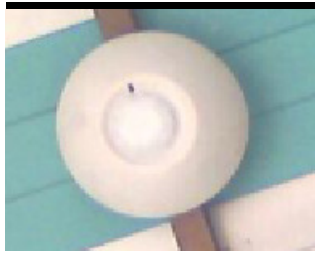

Smoke/gas detectors:

a) Wired or wireless smoke detector

This smoke detector detects smoke by a couple of infrared diodes, which is suitable for detecting the smoke in house, shop, hotel, restaurant, office building, school, bank, library and storehouse etc.

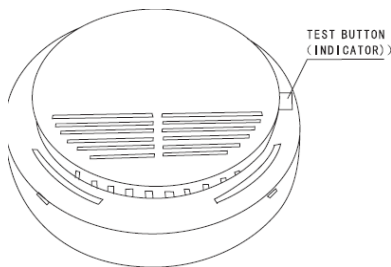

b) Wired or wireless gas detector

The product is ceiling mounted gas detector with high stability. It is used for detecting leaking gas and suitable for the safety of residential house, villas, hotels, boarding house etc.

Detecting the gas heavier than air: installation height from floor: 0.3m ~ 1.0m, semi-diameter to gas sources: < 1.5m; detecting the gas lighter than air: installation height from ceiling 0.3m ~ 1.0m, semi-diameter to gas sources: < 1.5m.

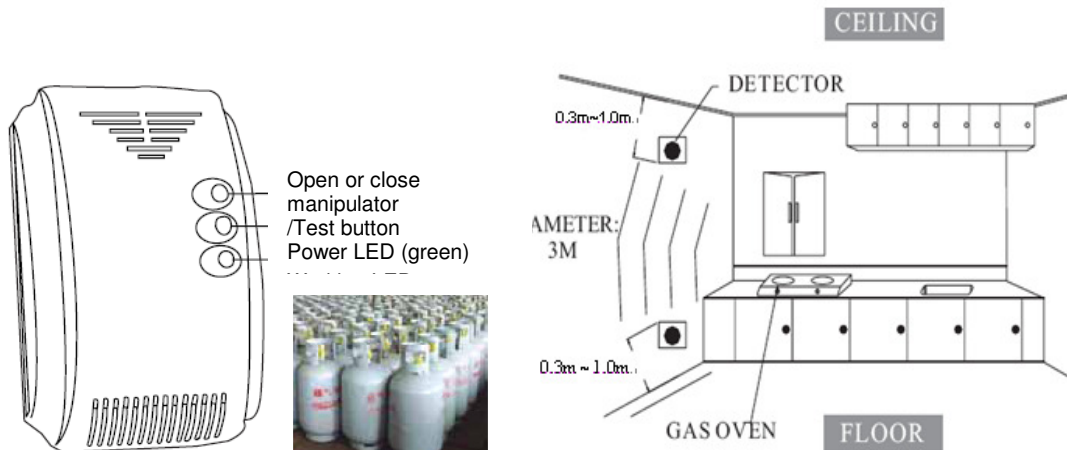

Wired alarm zones

The alarm system have DC12V output, it can be used to supply the voltage for the wired sensors. The alarm system support two wired zones L1/L2 are the 2 wire alarm inputs.
Note: The wired zone support NO/NC wired sensor.

6. Operation Instructions: *the factory password is: 0000*

6.1 Keyboard setting:

- A long beep sound for all the proper operations
- Two short sounds for wrong settings.

6.1.1 Password: Open/Close password protection function, Change user's password

Command: *11* Password protection enable
Command: *10* Password protection disable
Command: *7xxxx* Password modification;
Ex: new password 8888 enter command *78888*

6.1.2 Siren alarm sound enable/disable:

Command: #00# disable siren alarm sound
Command: #01# enable siren alarm sound A

6.1.3 Set up alarm calling telephone numbers:

Command: #NTTTT#

Description:

A maximum of 6 numbers can be entered to the system:

- **N:** value 1 to 6 (1 is the first input number and when there is an alarm condition the number is called first)
- **TTTTT:** is the phone number to be dialed (maximum 13), please enter it as you would make the phone call dialing.
- **Ex: #18005558888#** system will call this number 800555888 when there is an alarming condition.

6.1.4 Delete alarm calling telephone numbers:

Command: #N#:

Description:

N (1-6): delete the entering telephone number.

6.1.5 Siren alarm sound time out:

Command #9xx#

Description: **xx=** 00-30 (minutes) ex: #95#, When alarming: the siren will sound 5 minutes.

6.1.6 Alarming delay:

Command: #7xx#

Description: **xx=** 00-99 (seconds) ex: #730#, the system will alarm after sensor is triggered 30 seconds.

6.1.7 ARMING delay:

Command: *4xx*

Description: **xx=** 00-99 (seconds) ex: *430*, the system will auto ARMING after press ARM key 30 seconds.

6.1.8 Remote telephone ringing times:

Command: *6x*

Description: **x=** 0-9 (seconds) ex: *63*, if will automatically get through after ringing 3 times,
60, means no ringing times.

6.1.9 Siren sound feedback when using the remote control:

Command: *21*

Description: The siren will have a short feedback sound when you press remote control

Command: *20*

Description: The siren feedback sound is off when you press remote control, only have buzzer sound.

6.1.10 Voice reminder function on/off and buzzer sound on/off:

Command: *041* The voice reminder function: OFF

Command: *040* The voice reminder function: ON

Command: *99* The buzzer sound: OFF

Command: *98* The buzzer sound: ON.

6.1.11 Alarm message recording:

Command: *0xxxx*

Description:

- xxxx = 4 numbers password
- You have 10 seconds to record your alarm message
- The system gives a long sound which means the record is successful.
- Using the telephone handset To hear the recording voice message, press *9* press any key to quit

6.1.12 Register and Delete remote controller/sensors:

Register Remote controller:

Command: *0*

Description: After pressing *0* on the alarm panel keyboard, then press any button of the remote controller within 10 seconds. A long "Beep" sound means successfully.

Register Sensor:

Command: *01*

Description: After pressing *01* on the alarm panel keyboard, then trigger the sensor within 10 seconds. A long "Beep" sound means successfully.

Command: *03*

Description: Learning wireless keypad.

Assigning Zone Number;

Command: *8xx*

Description: xx = 00-99 zones number, ex: *816*, assign the register sensor to zone 16.

Delete all Remote Controllers

Command: *02*

Description: Delete all of the remote controllers

Delete all Sensors

Command: #8996#

Description: Delete all detectors.

6.1.13 Setting wired zones L1/L2:

Command: *061* Enable wired zones

Command: *060* Disable wired zones

Command: *91010* Line 1 input: NC

Command: *91011* Line 1 input: NO

Command: *91012* Line 1 input: State change

Command: *91020* Line 2 input: NC

Command: *91021* Line 1 input: NO

Command: *91022* D Line 1 input: State change

6.1.14 Zone mode settings:

Command: #8xxA#

Description:

xx = 00-99 (zone number);

A= zone mode (0-7) 8 modes

- 0: Bypass mode: The selected zone is disabled at all time
- 1: Common mode: The selected zone is active when the system is arming
- 2: Intelligent mode: The selected zone is disable when system INTELLIGENT ARMING
3. Emergency mode: The selected zone is active at all time even the system is not arming
i.e; Smoke, Gas, Heat, Emergency panic sensors, ...
4. Multi-Zones Triggered Mode: The selected zone is assigned to the Multi-Zones mode and the alarm condition is triggered when 2 or more zones in this mode are active within 30 seconds.
5. Delay-alarm mode: When the selected zone is active the system will enter the delay alarm mode.
6. Repeat triggered mode: when the detector in the selected zone is triggered once, the system will not alarm immediately, only when it is triggered again within 30 seconds after the first trigger, the system will alarm.
8. Doorbell mode: The control panel will sound "ding dong" as the doorbell when the selected zone is active.

6.1.15 Alarm event history:

Command: x

Description: x = (0-9) press key 0~9 to inquiry the latest 10 alarm events and display alarm defense area (0 means the most recent event).

6.1.16 Telephone line tampering detection:

Command: *51* Description: the system will alarm when telephone lines disconnect or failure

Command: *50* Description: the system will not detect telephone lines disconnection or fault.

6.1.17 Remote controller enable/disable:

Command: *31* Description: Remote controller is disabled.

Command: *30* Description: Remote controller is enabled

6.1.18 Remote control output OUT:

Command: #80A#

Description: A = 0-9

0: OUT line out is disabled

1: OUT line out is only active in the DISARMING mode

2: OUT line out is only active in the Intelligent ARMING mode and during the alarming period.

3: OUT line out is only active in the Intelligent ARMING mode and is disable during the alarming period.

4: OUT line out is only active in the ARMING mode and during the alarming period.

5: OUT line out is only active in the ARMING mode and is disable during the alarming period

6: OUT line out is only active in any ARMING condition mode and during the alarming period.

7: OUT line out is only active in any ARMING condition mode and is disable during the alarming period

8: OUT line out is active in the alarm mode

9: OUT line out is active

6.1.19 Setting up the system time and timing ARM/DISARM:

Command: *07HHMM* **System time setting**

Description: HH = hour (0-23) , MM= minute (0-59); Ex: *071830*, means set up the time to be 18:30

Command: #07HHMMA# **Alarm arming timer**

Description HH = hour (0-23) , MM= minute (0-59); Ex: *071830*, means set up 18:30

A = 0-9: 9 group of alarm timing can be programmed: 0 = disable arming timer; group 1 to group 5 timer can be used repeatedly, group 6 to group 9 timer can be used only one time; Ex: #0700000# all timer off.

Command: #08HHMMA# Alarm disarming timer

Description HH = hour (0-23) , MM= minute (0-59); Ex: *071830*, means set up 18:30

A = 0-9: 9 group of alarm timing can be programmed: 0 = disable arming timer; group 1 to group 5 timer can be used repeatedly, group 6 to group 9 timer can be used only one time; Ex: #0800000# all timer off.

Command: #09HHMMA#

Description: “HH” means hour(2-degits), “MM” means Minute(2-degites), the hour is 24 clock.

“A” (0-9) : Can set 9 groups timing time strike: 0 = disable timing time strike; group 1 to group 5 timing strike can be used repeatedly, group 6 to group 9 timing strike can be used only one time;

Ex: #0900000# close all timing arm

6.2 GSM messaging prompting:

6.2.1 Editing SMS prompting messages; (9 groups)

SMS: 0000AB

Description: Editing sms, 0000 is password, “A” (1-9), means 1-9 group numbers; “B” means SMS content(e.g. this is a door sensor alarm)

e.g. send sms:” 00001 this is a door sensor alarm” this is the first group self editing sms.

SMS: 0000A*

Description: Query the editing sms contents, 0000 is password, “A” (1-9), means 1-9 group numbers; e.g. send sms: 00001*, the system will reply the first group sms contents.

Command: #03AAB#

Description: sms direction after alarming, “AA” zone number (00-99), “B” is 9 group editing sms contents(0-9). EX #03011#, the system will send the first group SMS contents to user after zone 1 be triggered.

6.2.2 Set the types of 6 groups alarming telephone number and power failure

Command: #AB#

Description: Set the types of 6 groups alarming telephone number, A=1-6 means 1-6 groups alarming telephone number; B=2-4 , 2 means only give a call to user when the system alarming, 3 means only give a SMS to user when the system alarming, 4 means give call and SMS to user when the system alarming.

e.g. #14# means the 1st group telephone number can send SMS and make a call;

#12# means the 1st group telephone number only can make a call, cannot send SMS;

Command: *05A*

Description: Set power failure alert, A = 0-7, 0 means close power failure alert function, 1-6 means send to which group telephone number when power failure. 7 means send power failure alert SMS to all 6 group telephone numbers.

6.2.3 Set the brightness adjustment of digital display

Command: *08A*

Description: A(0-7), 8 level brightness adjustment.

6.2.4 SMS commands: where 0000 is the password

- SMS: 0000CF** Disarm the system
- SMS: 0000SF** Arm the system
- SMS: 0000bF** Intelligent arm the system
- SMS: 0000STATUS** Querying status of the system
- SMS: 0000ON** Set the OUT line active
- SMS: 0000OFF** Disable the OUT line

Note: All the above mentioned commands can be operated by editing text message with the format of “password + the content of command”. For example If setup the first phone number as 87654321 by SMS, edit “0000#187654321# ”and send it to the alarm panel;

7. Remote Controller (Key fob) Description

7.1. Set up Arm



Press “” button on the remote controller, and the LED display “SF”, means system “Armed”.

7.2 Set up Disarm

Press “” button on the remote controller, and the LED display “CF”, means system “Disarmed”.

7.3. Emergency Alarm

Press “” button on the remote controller for emergency help, And the LED display “99”.

Press “” button on the remote controller one time is silent alarm, while press “” button twice or long time the siren will sound.

7.4. Intelligent Arm

Press “” button on the remote controller and the LED display “bF”, means system “Intelligent Armed”.

8. Alarm Panel LED Screen Indicator Status Description:

| LED Indicator Display | Status Description |
|-----------------------|---------------------------------|
| SF | Arm |
| CF | Disarm |
| 99 | Emergency Alarm |
| bF | Intelligent Arm |
| F1 | Telephone Line Disconnect Alarm |
| F3 | No Registered Sensors |
| F4 | GSM is unavailable |
| F5 | Turn on GSM |
| F6 | Access GSM network |
| 1-98 | Wireless Defense Zones |
| L1-L2 | Wired Defense Zones |

9. Remote Control the system:

You can use any telephone to dial the numbers of the system and it will put on automatically get through after system detecting the ring times you have been setup. When you hear the beep, input passwords (two beep sounds if the password is wrong, if the password input wrongly 3 times or no any operations within 20 seconds the phone will hang up automatically) and if it is correct, you can have remote control of the system, press # after accomplishing all operations, then you can implement other operations and hang up telephone.

Press "1" to monitor (Press "1" again for monitor 20 seconds more.)

Press "2" to start the siren

Press "3" to stop the siren

Press "4" to arm

Press "5" to disarm

Press "6" to play the recorded personal voice message

Press "7" to open 12V output

Press "8" to close 12V output

Press "9" to close the speaker (External)

Press "0" to open the speaker (External)

Press "#" to affirm and hang up

10. Handing Incoming Alarm Phone Calls

When sensors are triggered or emergency help, the alarm panel will dial up the setup telephone numbers automatically and give alarm rings based on settings. If the host's phone is in use or not able to connect, the system will dial next alarm phone, until it is dialed and hosts confirm. It will play records after receiving alarm phone and the operation methods are similar to remote setup.

11. Reset Factory Settings

Command:*80000*

Description: 0000 is default password (All settings will be cleared except all the registered sensors)

12. Copyright and Disclaimer

Copyright © 2014 VT TECH Corp. All rights reserved.

The user manual may be changed without prior notification.

This user manual, or any part thereof, may not be reproduced for any purpose whatsoever without the written authorization of VT TECH Corp., or transmitted in any form, either electronically or mechanically, including photocopying and recording.

In no event shall VT TECH Corp be liable for direct, indirect, special, incidental, or consequential damages (including but not limited to economic loss, personal injury, and loss of asset and property) arising out of the use or inability or illegality to use the product or documentation.

If you encounter any problems when using our products, and cannot solve them by yourself, please contact our technical support team by writing an E-Mail to support@vttech.com.